

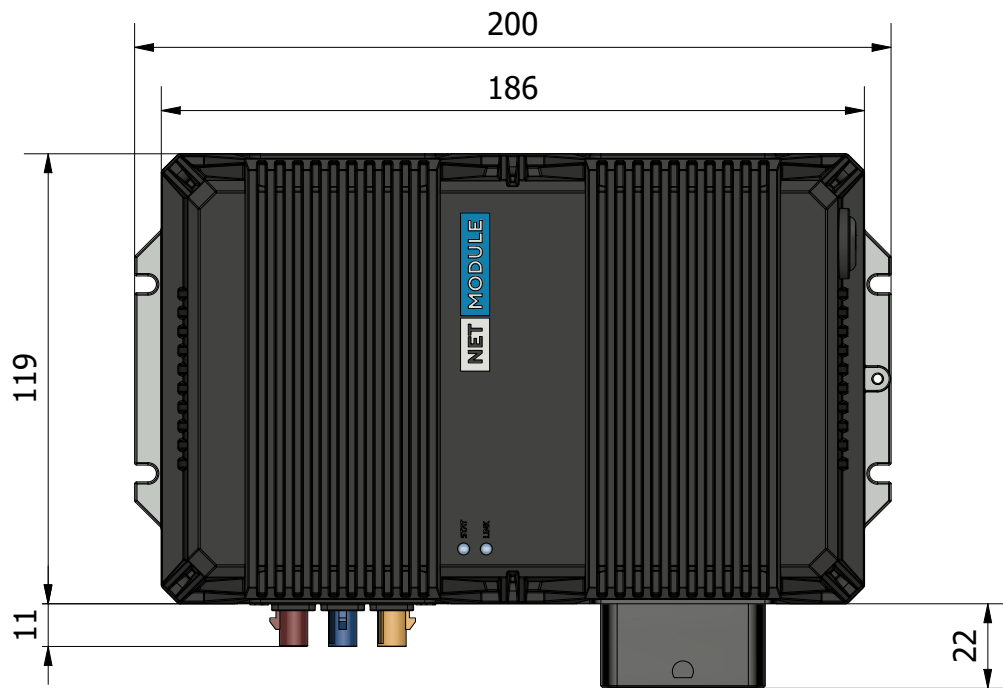

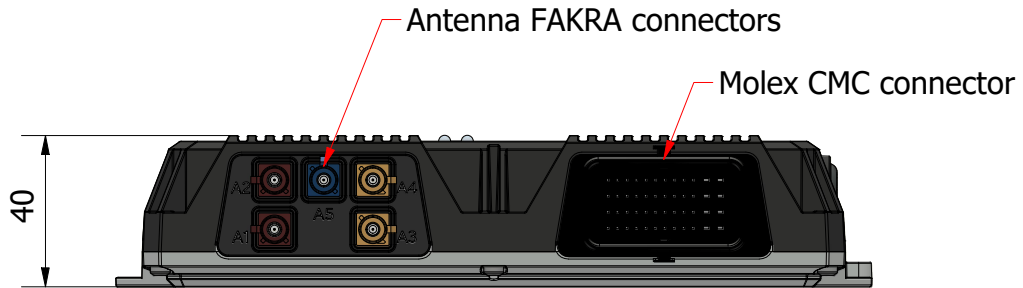

1. Outline Dimensions



All dimensions in mm

Material	Oberflächenbeschichtung	Fläche N/A	Gezeichnet rk 08.02.2021
Dimension		Gewicht N/A	Geprüft jla 05.01.2022
Allgemeintoleranzen	Verwendung / Bezeichnung		Geändert rk 05.01.2022
NetModule AG Phone: +41 (0)31 985 25 10 Fax: +41 (0)31 985 25 11 info@netmodule.ch www.netmodule.com 	NG800 Installation Instruction	Massstab A4 	Blatt 1 / 7 
		Artikelnr / Zeichnungsnr	Version 01

2. Mounting Specification

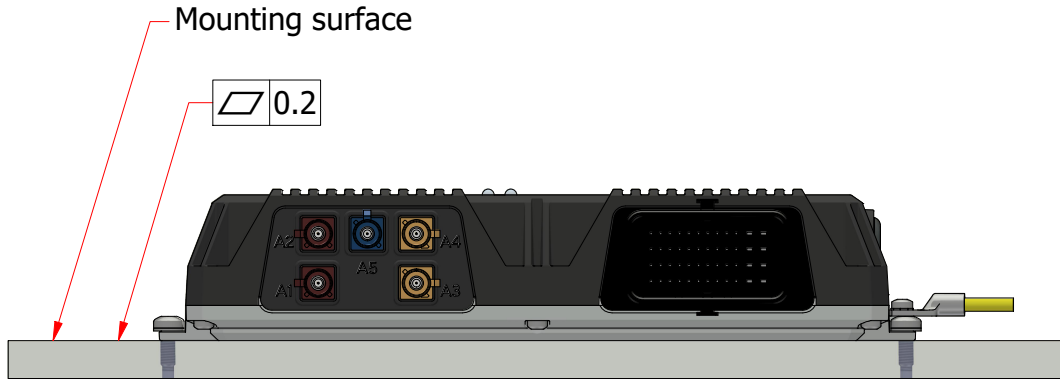

To optimise cooling of the device, allow air flow around it and mount it to a metal surface if possible.

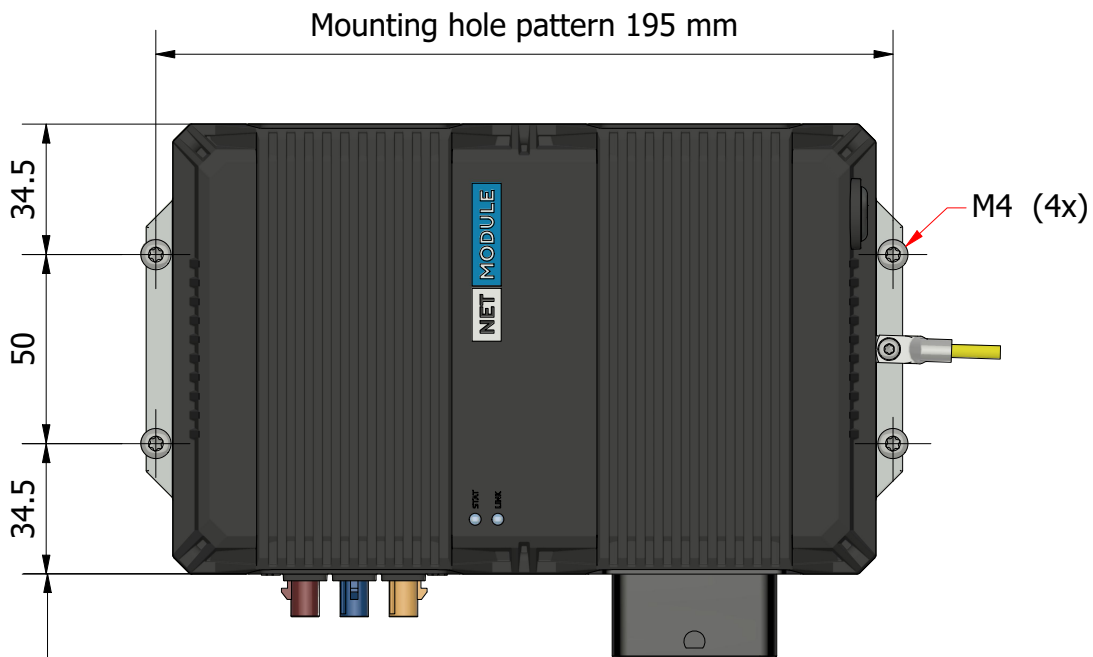

Recommendation: 90 mm space for cable mounting

Material	Oberflächenbeschichtung	Fläche N/A	Gezeichnet rk 08.02.2021
Dimension		Gewicht N/A	Geprüft jla 05.01.2022
Allgemeintoleranzen	Verwendung / Bezeichnung		Geändert rk 05.01.2022
NetModule AG Maulbeerstrasse 10 CH-3011 Bern Phone: +41 (0)31 985 25 10 Fax: +41 (0)31 985 25 11 info@netmodule.ch www.netmodule.com	NG800 Installation Instruction	Massstab A4	Blaft 2 / 7
			Version 01
NET MODULE		Artikelnr / Zeichnungsnr	

3. Device Mounting

3.1 Place the screw and lock washer over the mounting hole (Figure 2)

3.2 Tighten the screws | Drive type: Torx T20 | Torque: 2.5Nm (Figure 3)

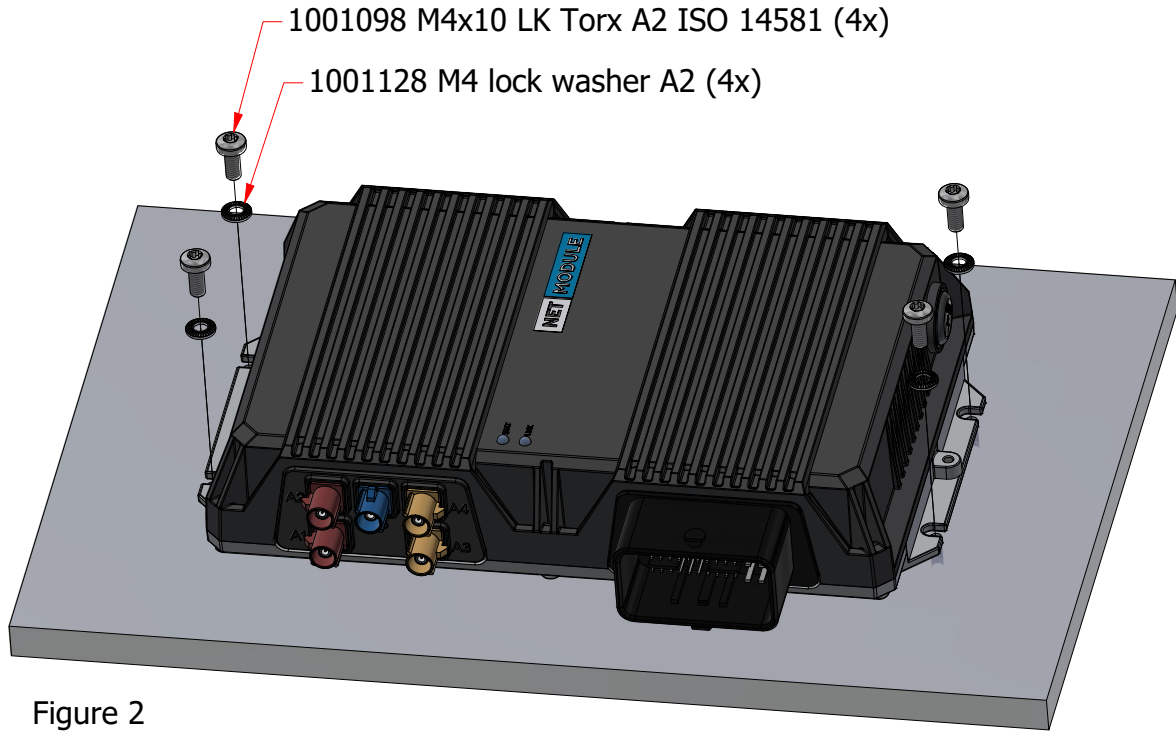

Figure 2

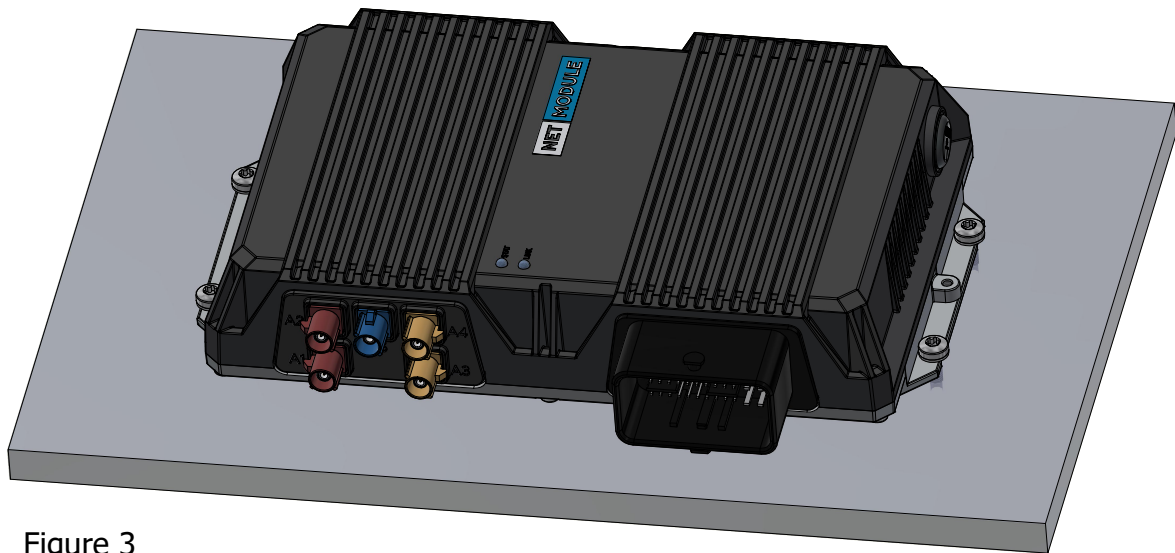

Figure 3

© NetModule AG. All rights reserved, also regarding any disposal, exploitation, reproduction, editing, distribution, as well as in the event of applications for industrial property rights.

Material	Oberflächenbeschichtung	Fläche	Gezeichnet	
		N/A	rk	08.02.2021
Dimension	Verwendung / Bezeichnung	Gewicht	Geprüft	
		N/A	jla	05.01.2022
Allgemeintoleranzen	NG800 Installation Instruction	Geändert		
		rk 05.01.2022		
		Massstab	A4	Blaft
NetModule AG Phone: +41 (0)31 985 25 10 Maulbeerstrasse 10 Fax: +41 (0)31 985 25 11 CH-3011 Bern info@netmodule.ch www.netmodule.com				3 / 7
		Artikelnr / Zeichnungsnr		Version
				01

4. Earthing Cable Mounting (optional)

4.1 Place the screw, lock washer and cable lug over the mounting hole (Figure 4)

4.2 Tighten the screw | Drive type: Torx T10 | Torque: 1Nm (Figure 5)

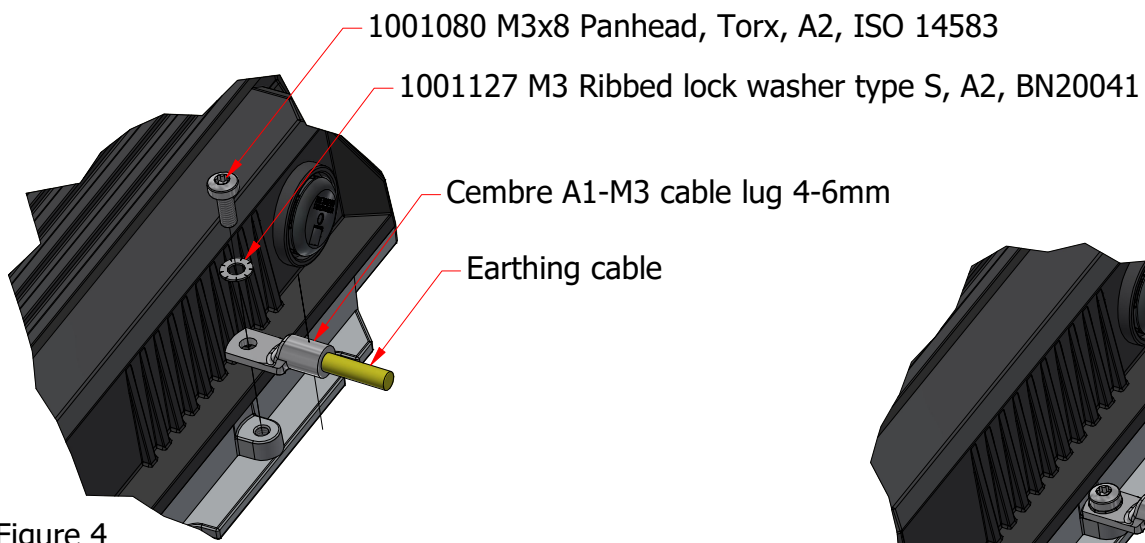
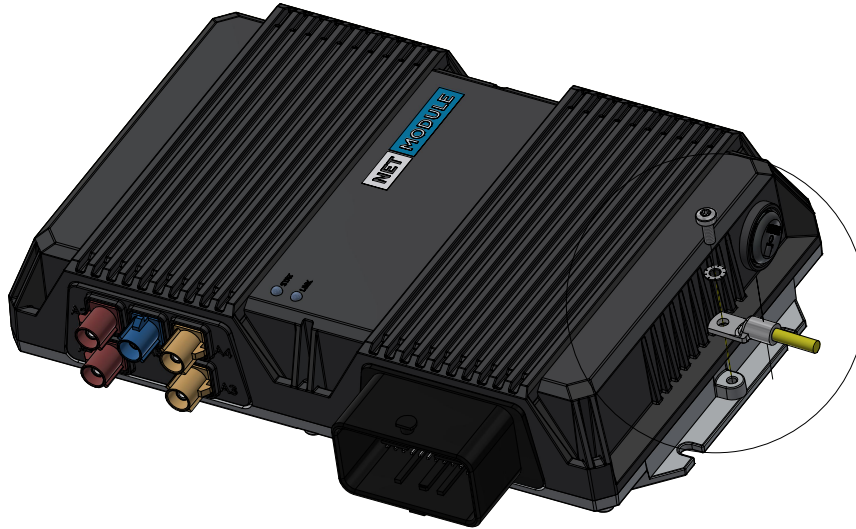

Figure 4

Figure 5

Material	Oberflächenbeschichtung	Fläche N/A	Gezeichnet rk 08.02.2021
Dimension		Gewicht N/A	Geprüft jla 05.01.2022
Allgemeintoleranzen	Verwendung / Bezeichnung		Geändert rk 05.01.2022
NetModule AG Phone: +41 (0)31 985 25 10 Fax: +41 (0)31 985 25 11 Maulbeerstrasse 10 CH-3011 Bern info@netmodule.ch www.netmodule.com	NG800 Installation Instruction	Massstab A4 Blatt 4 / 7	Artikelnr / Zeichnungsnr Version 01

5. Antenna Cable Mounting

- 5.1 Connect the antenna cables according the port layout (Figure 6)
- 5.2 Recommended cable guideline (Figure 7)

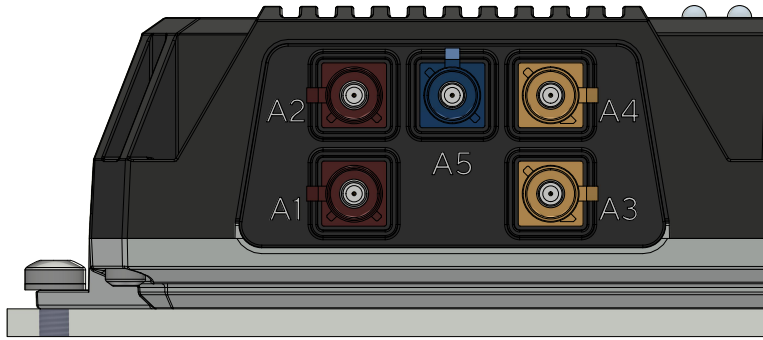

Port Layout 5x FAKRA Insert		
FAKRA Code	Label	Application
D	A1	LTE
D	A2	LTE
I	A3	WLAN
I	A4	WLAN
C	A5	GNSS

Figure 6

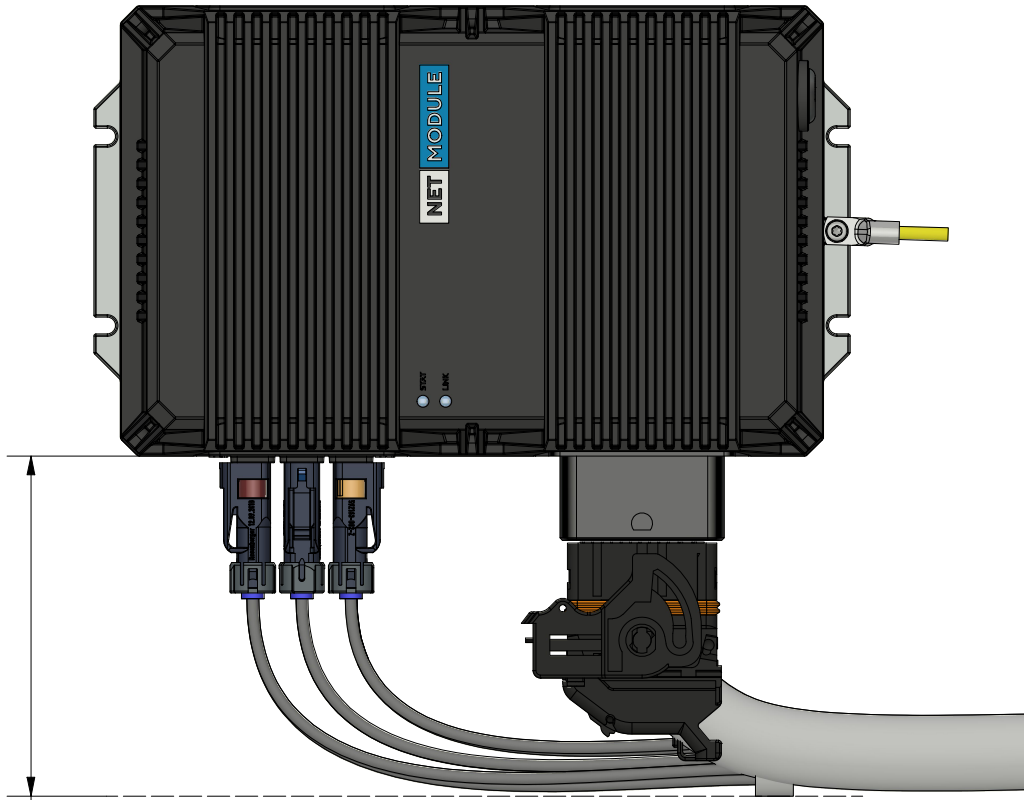

Recommendation: 90 mm space for cable mounting
 Refer to cable specs for bending radius

Figure 7

Material	Oberflächenbeschichtung	Fläche N/A	Gezeichnet rk 08.02.2021	
Dimension		Gewicht N/A	Geprüft jla 05.01.2022	
Allgemeintoleranzen	Verwendung / Bezeichnung		Geändert rk 05.01.2022	
NetModule AG Maulbeerstrasse 10 CH-3011 Bern Phone: +41 (0)31 985 25 10 Fax: +41 (0)31 985 25 11 info@netmodule.ch www.netmodule.com	NG800 Installation Instruction	Massstab A4	Blatt 5 / 7	
		Artikelnr / Zeichnungsnr		Version 01

© NetModule AG. All rights reserved, also regarding any disposal, exploitation, reproduction, editing, distribution, as well as in the event of applications for industrial property rights.

6. Molex CMC Cable Mounting

- 6.1 Place the cable with the molex connector (Figure 8)
- 6.2 Turn the bracket clockwise to the position unlocked (Figure 8)
- 6.3 Place the molex cable into the molex connector until the guide rail of the bracket is in the right position to hold the guide bolt of the molex connector (Figure 9)
- 6.4 Turn the bracket counter-clockwise to push the molex cable into the connector (Figure 10)
- 6.5 Snap-In the bracket to lock the connector (Figure 11)

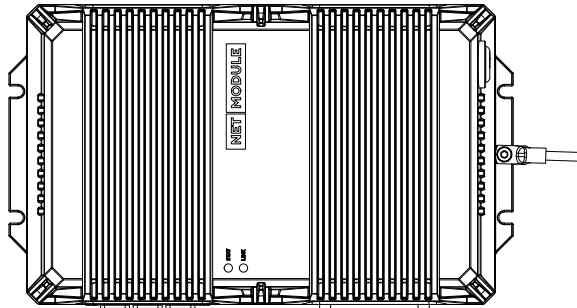

Figure 8

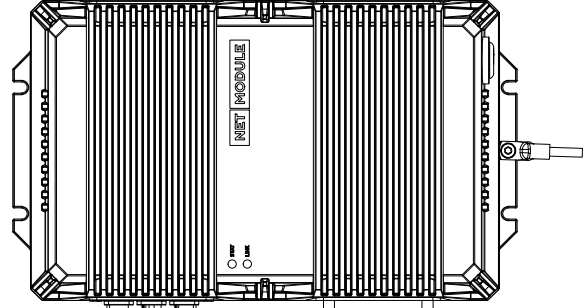

Figure 9

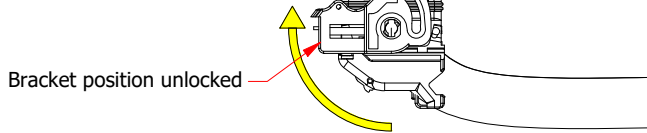

Figure 10

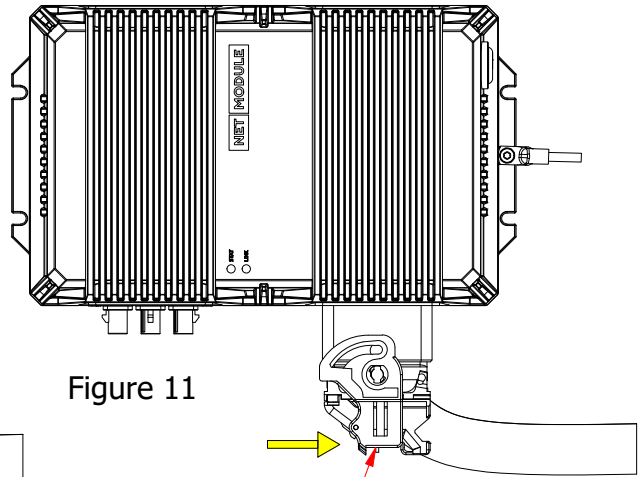

Figure 11

Bracket position locked

Material	Oberflächenbeschichtung	Fläche N/A	Gezeichnet rk 08.02.2021	
Dimension		Gewicht N/A	Geprüft jla 05.01.2022	
Allgemeintoleranzen	Verwendung / Bezeichnung	Geändert rk 05.01.2022		
NetModule AG Maulbeerstrasse 10 CH-3011 Bern Phone: +41 (0)31 985 25 10 Fax: +41 (0)31 985 25 11 info@netmodule.ch www.netmodule.com	NG800 Installation Instruction	Massstab	A4	
				Blatt 6 / 7
		Artikelnr / Zeichnungsnr		Version 01

7. Valid Device Mounting Positions

7.1 No mounting position restrictions

Horizontal mounting on x/y surface

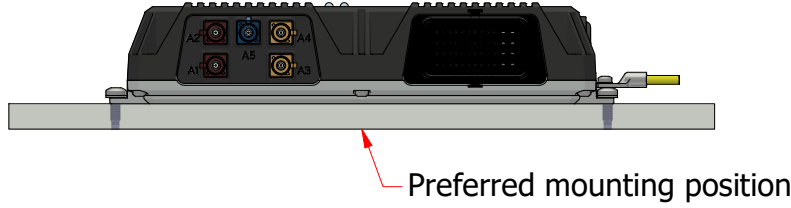

Vertical mounting on x/z surface



Horizontal mounting on x/y surface



Material	Oberflächenbeschichtung	Fläche N/A	Gezeichnet rk 08.02.2021
		Gewicht N/A	Geprüft jla 05.01.2022
Dimension	Verwendung / Bezeichnung NG800 Installation Instruction	Geändert rk 05.01.2022	
Allgemeintoleranzen		Massstab A4	Blatt 7 / 7
NetModule AG Phone: +41 (0)31 985 25 10 Fax: +41 (0)31 985 25 11 Maulbeerstrasse 10 CH-3011 Bern info@netmodule.ch www.netmodule.com			Artikelnr / Zeichnungsnr Version 01